

**Application:** shaping, broaching and thickening

**Machine:** shapers, multilateral profile millers, surfacers and thickeners

**Characteristics:**

- » width 40 mm, thickness 4 mm
- » knives can operate with limiters (manual shift) or without (machine shift)
- » knife material – tool steel, SP
- » limiter material – structural steel, SP
- » the limiter prevents tool “kicking” at manual feed
- » the limiter has a profile cut 0,8 mm deeper

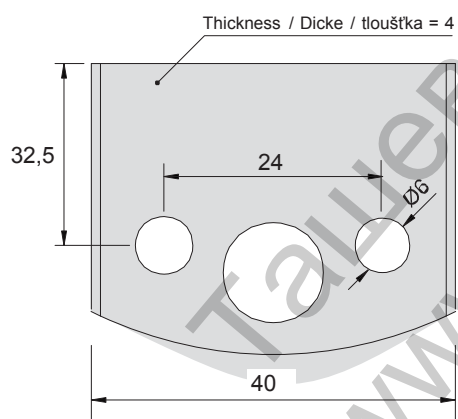
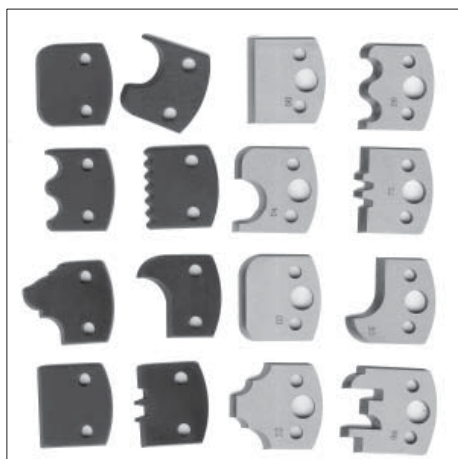

**Semiproducts for Profile Cutter Cut**

- » Semiproducts of both limiters and profile knives are in the same dimensions
- » For maximum profile depth up to 16 mm

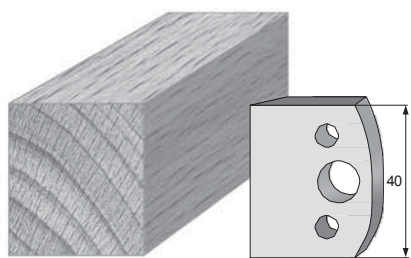

Profile number **00**

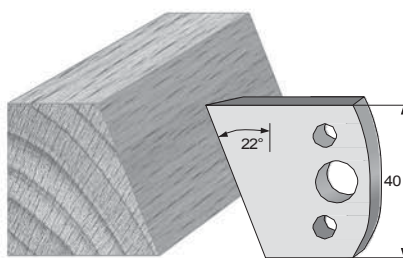

Profile number **01**

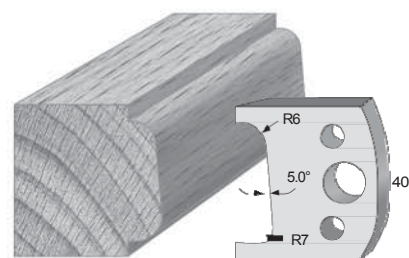

Profile number **02**

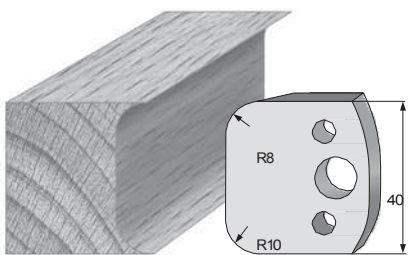

Profile number **03**

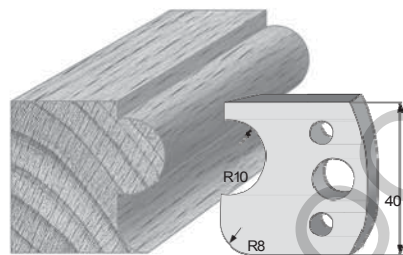

Profile number **04**

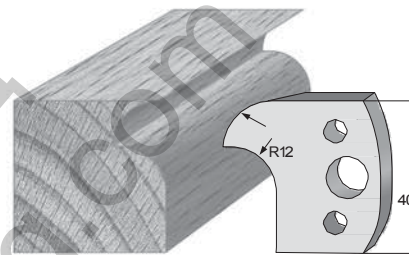

Profile number **05**

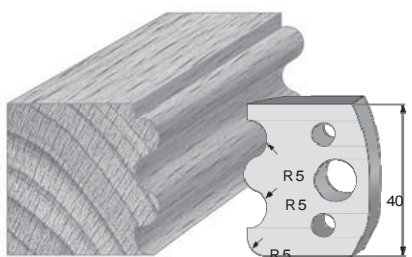

Profile number **06**

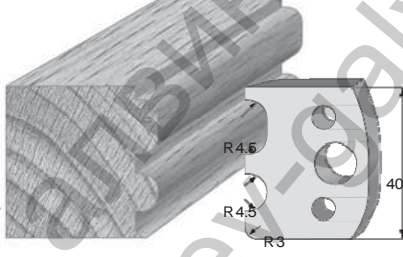

Profile number **07**

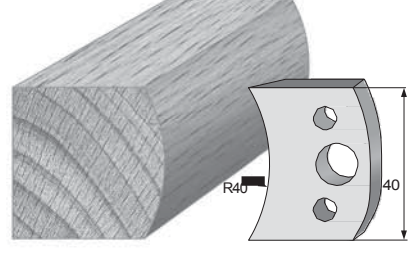

Profile number **08**

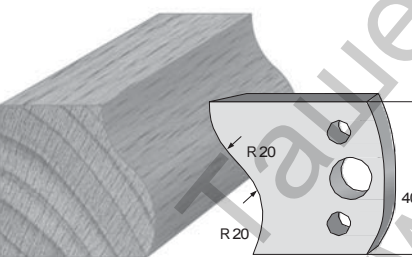

Profile number **09**

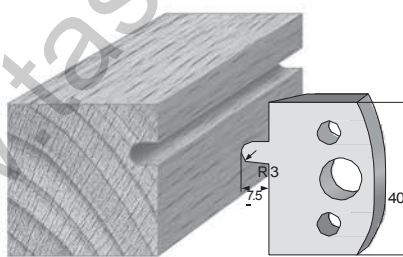

Profile number **10**

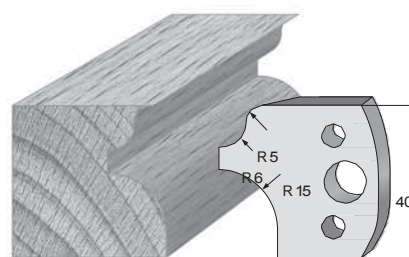

Profile number **11**

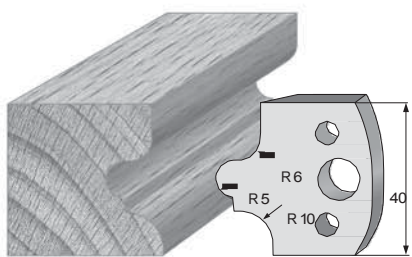

Profile number **12**

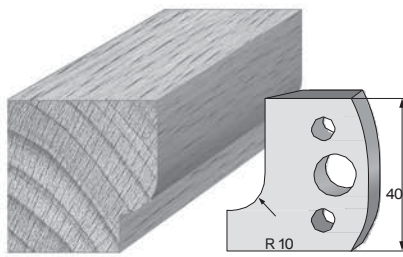

Profile number **13**

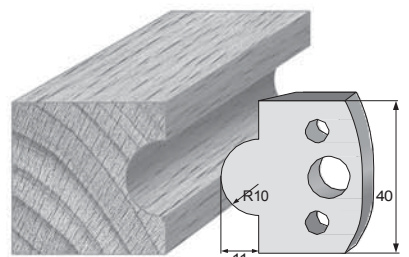

Profile number **14**

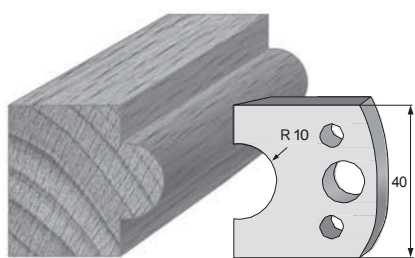

Profile number **15**

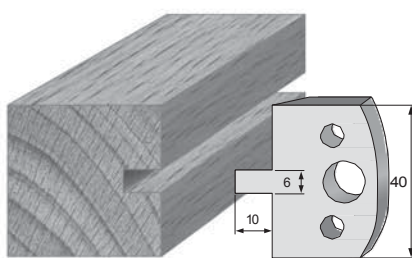

Profile number **16**

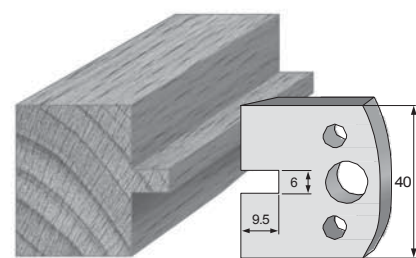

Profile number **17**

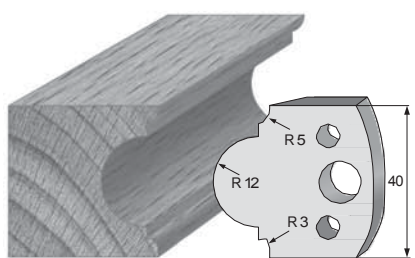

Profile number **18**

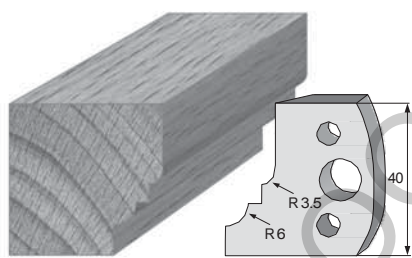

Profile number **19**

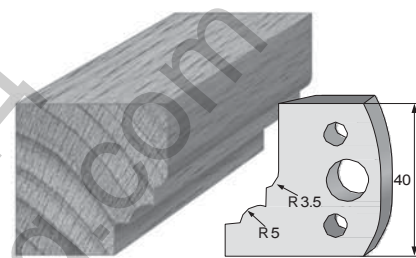

Profile number **20**

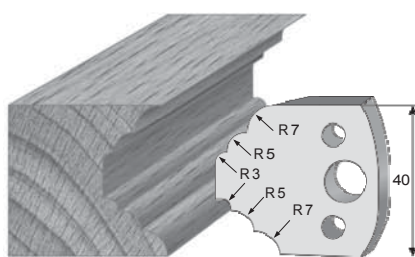

Profile number **21**

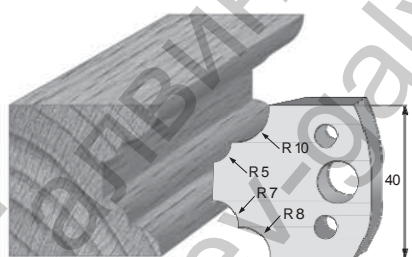

Profile number **22**

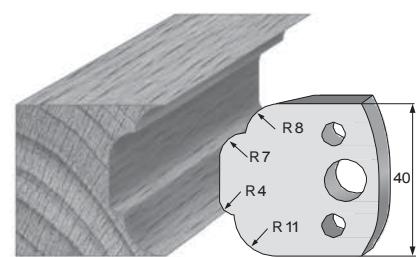

Profile number **23**

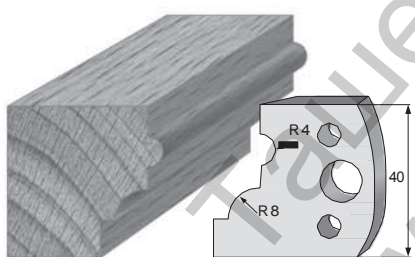

Profile number **24**

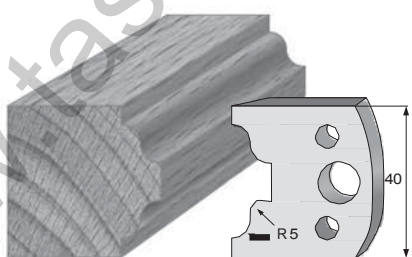

Profile number **25**

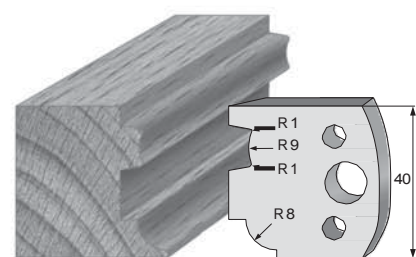

Profile number **26**

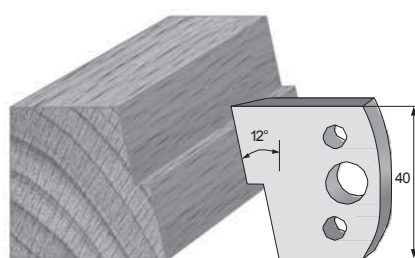

Profile number **27**

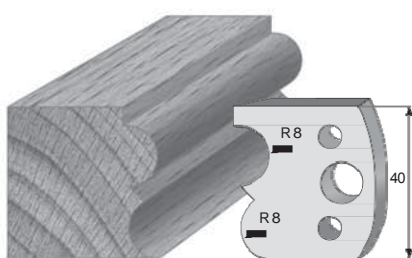

Profile number **28**

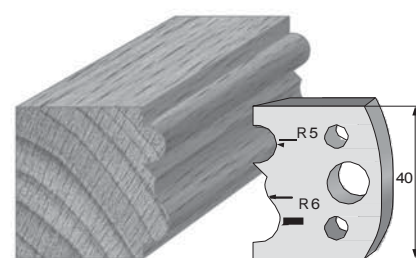

Profile number **29**



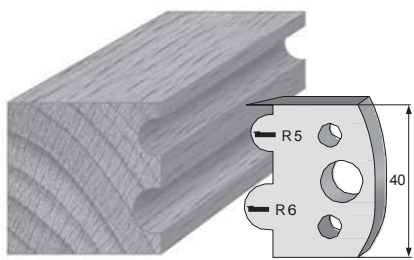

Profile number 30

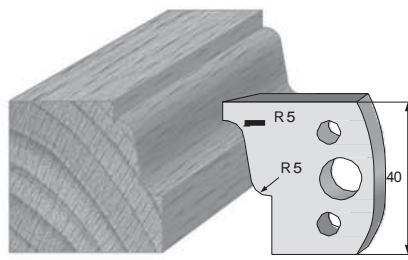

Profile number 31

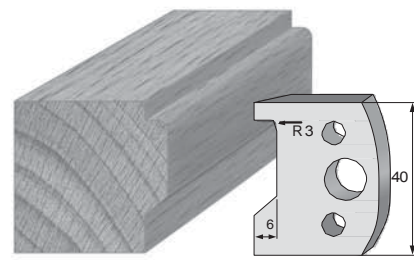

Profile number 32

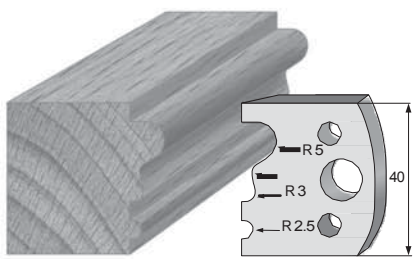

Profile number 33

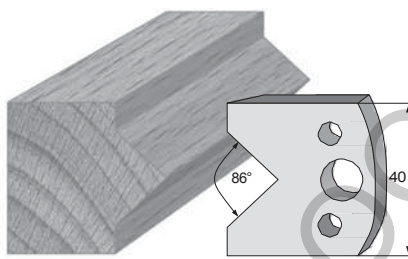

Profile number 34

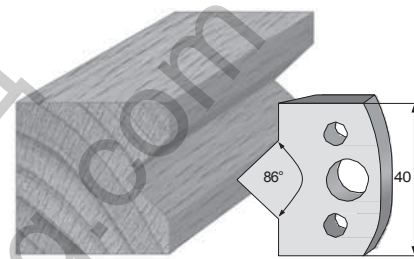

Profile number 35

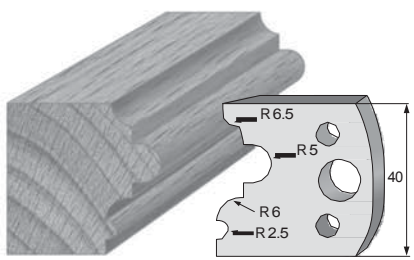

Profile number 36

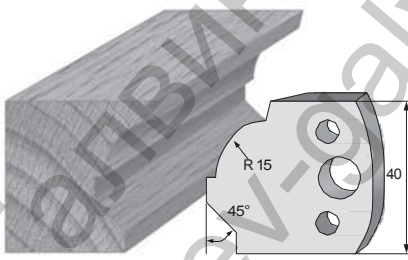

Profile number 37

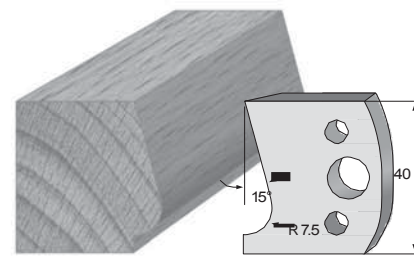

Profile number 38

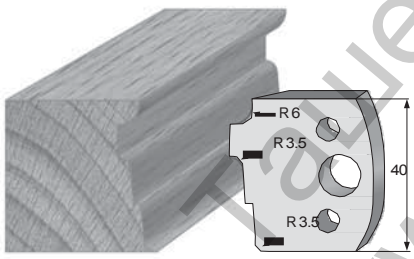

Profile number 39

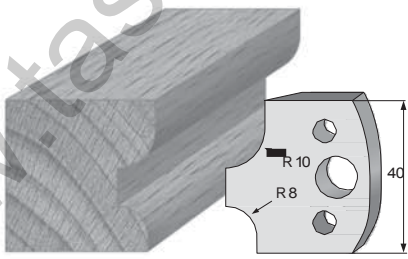

Profile number 40

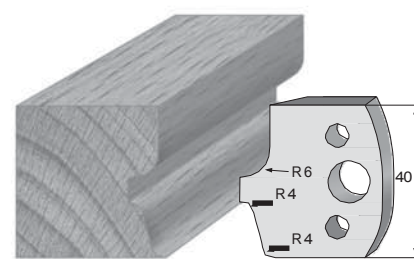

Profile number 41

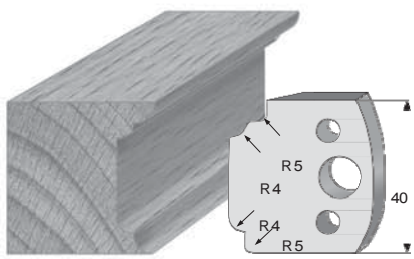

Profile number 42

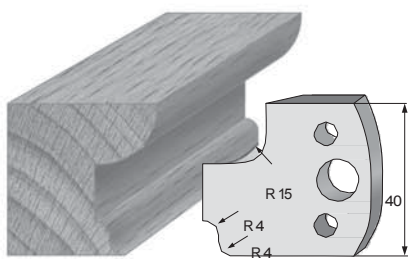

Profile number 43

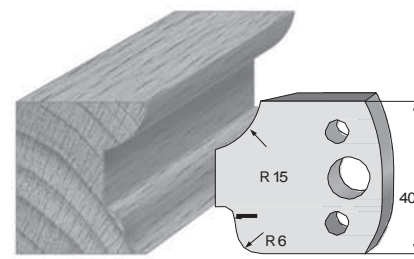

Profile number 44

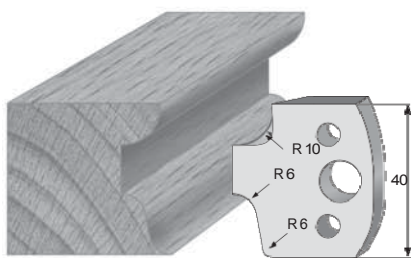

Profile number **45**

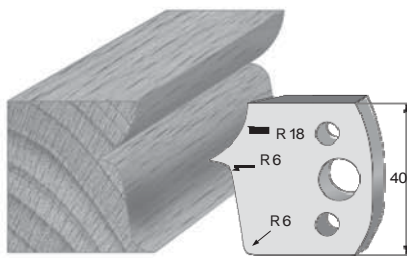

Profile number **46**

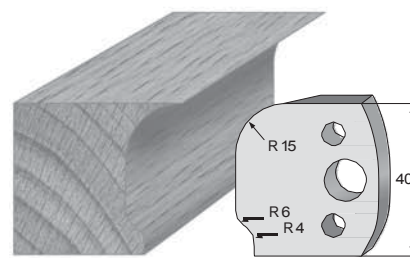

Profile number **47**

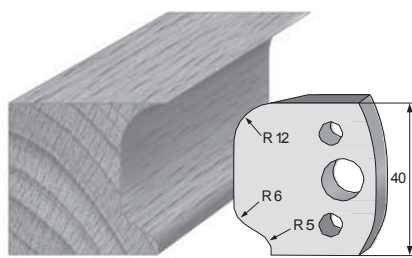

Profile number **48**

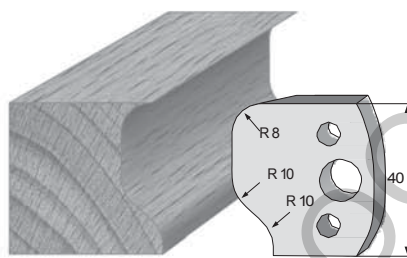

Profile number **49**

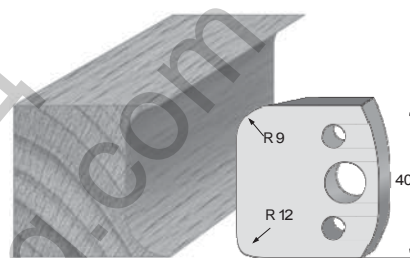

Profile number **50**

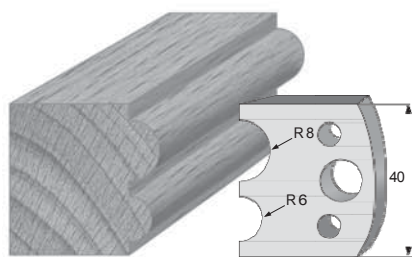

Profile number **51**

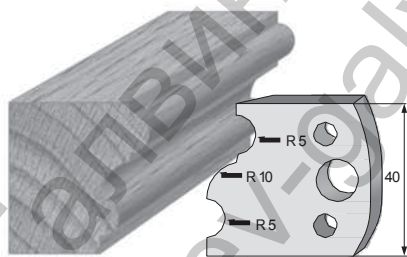

Profile number **52**

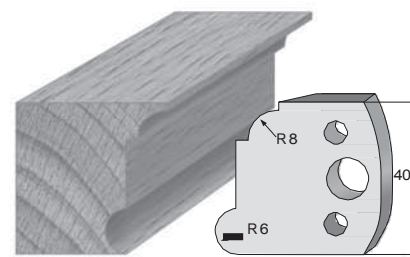

Profile number **53**

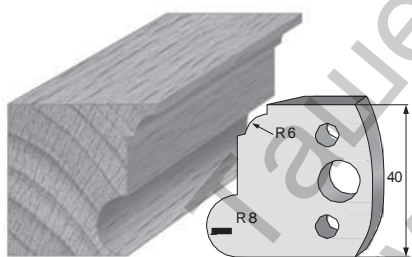

Profile number **54**

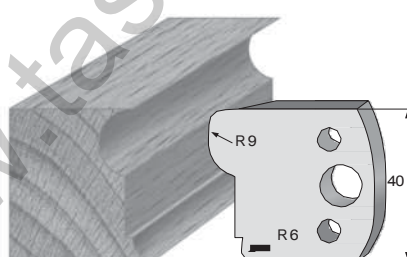

Profile number **55**

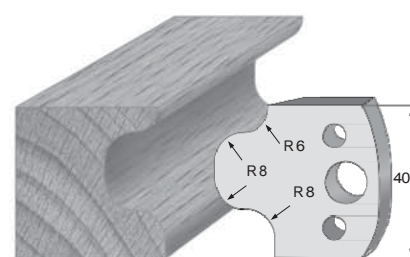

Profile number **56**

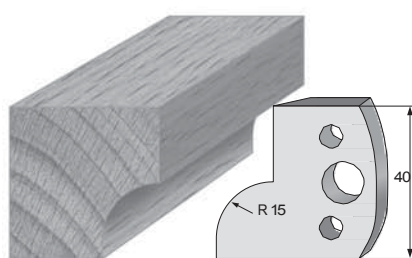

Profile number **57**

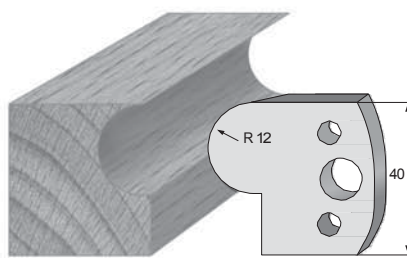

Profile number **58**

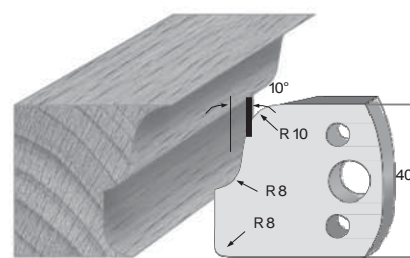

Profile number **59**



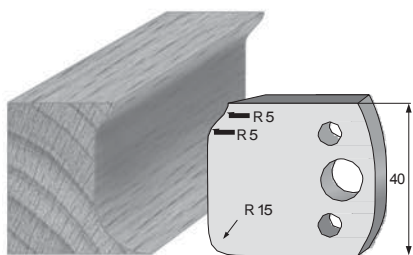

Profile number **60**

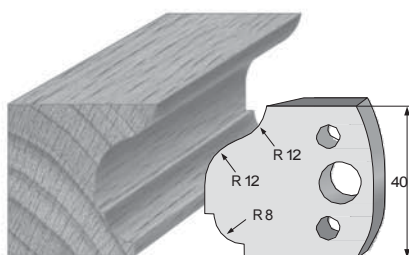

Profile number **61**

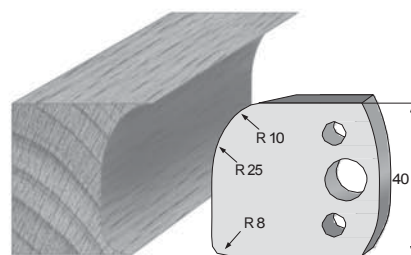

Profile number **62**

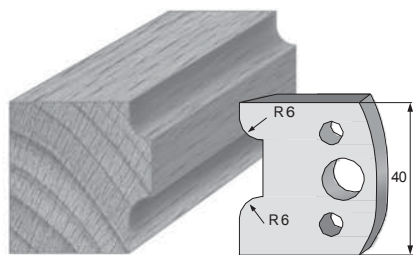

Profile number **63**

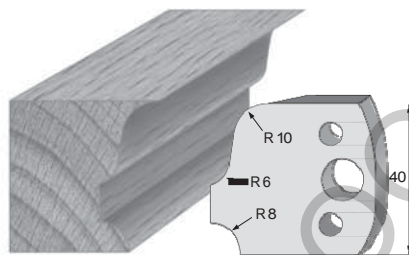

Profile number **64**

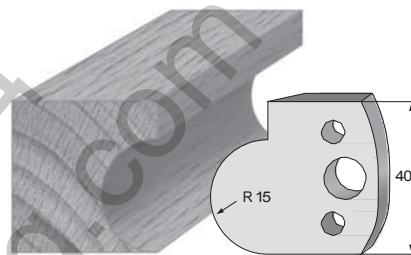

Profile number **65**

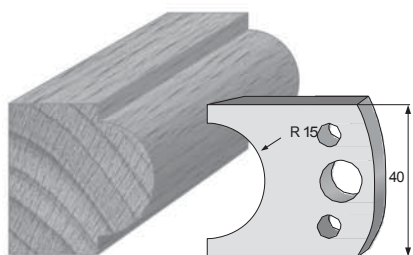

Profile number **66**

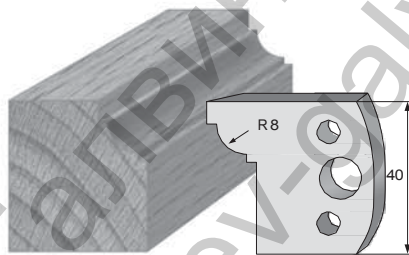

Profile number **67**

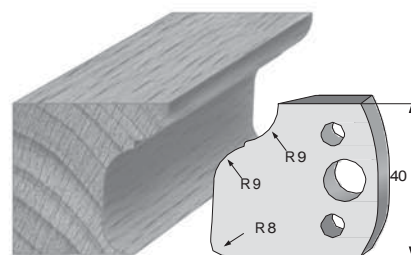

Profile number **68**

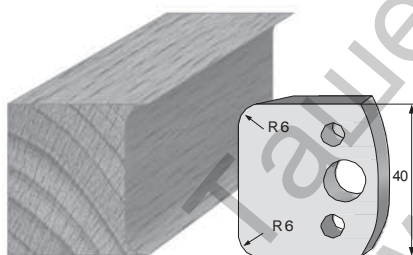

Profile number **69**

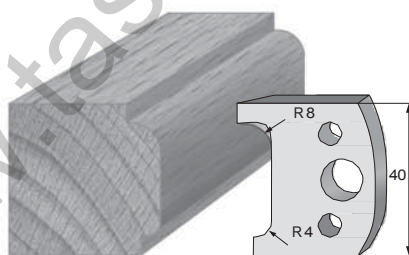

Profile number **70**

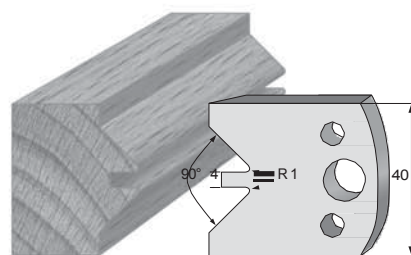

Profile number **71**

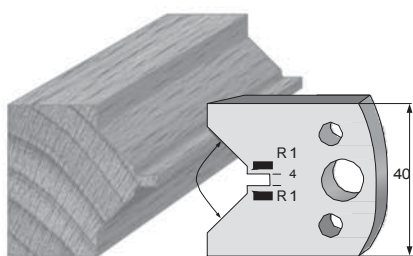

Profile number **72**

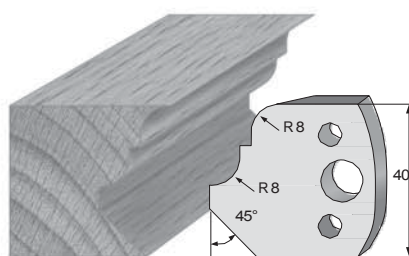

Profile number **73**

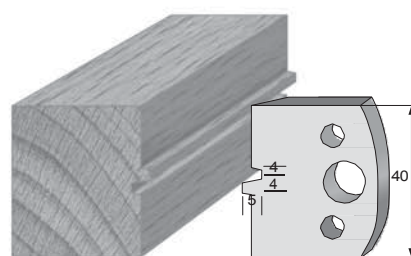

Profile number **74**

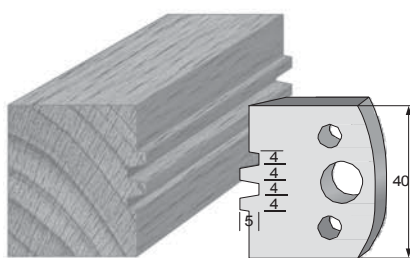

Profile number **75**

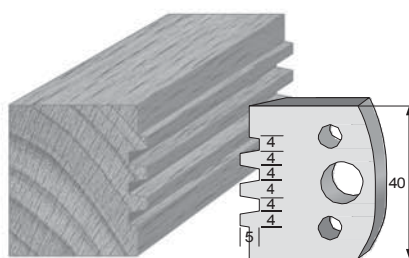

Profile number **76**

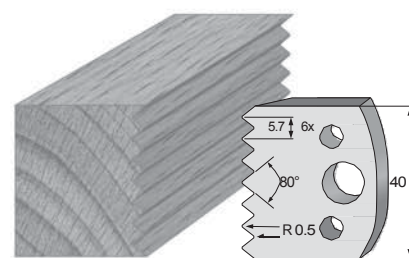

Profile number **77**

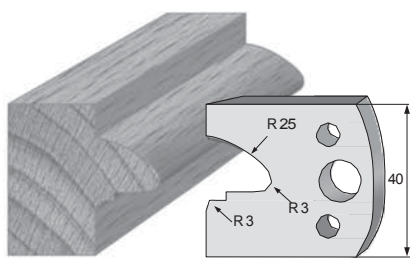

Profile number **78**

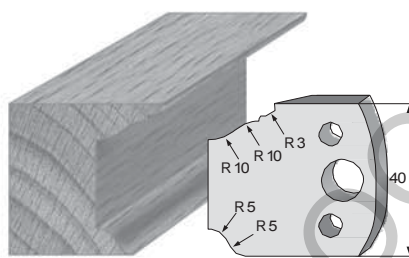

Profile number **79**

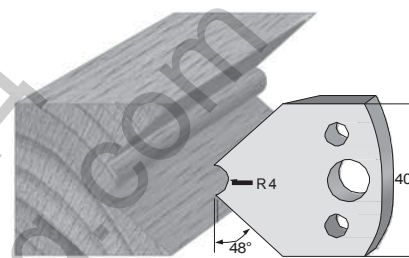

Profile number **80**

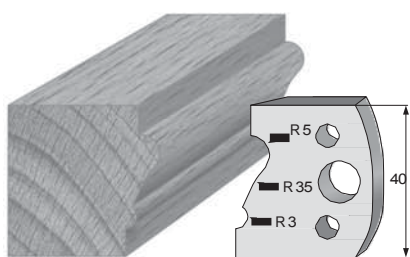

Profile number **81**

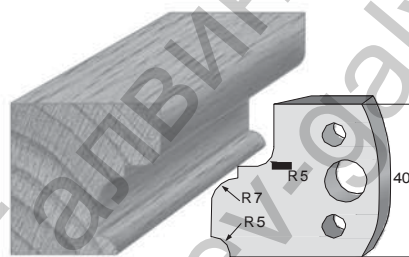

Profile number **82**

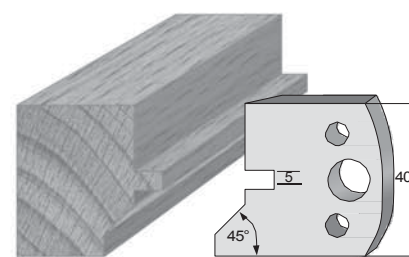

Profile number **83**

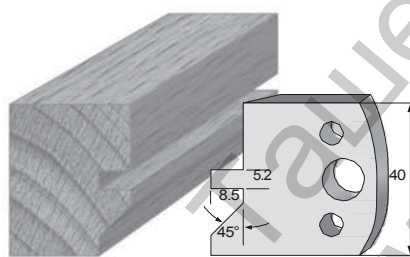

Profile number **84**

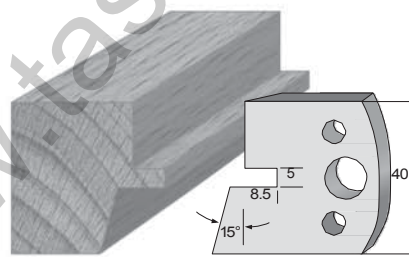

Profile number **85**

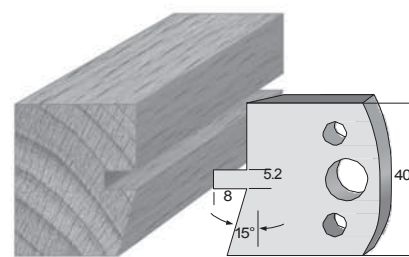

Profile number **86**

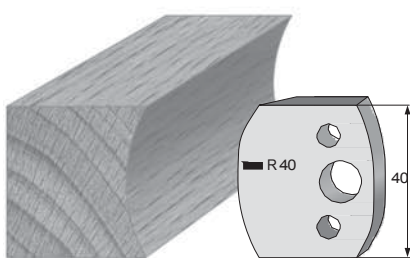

Profile number **87**

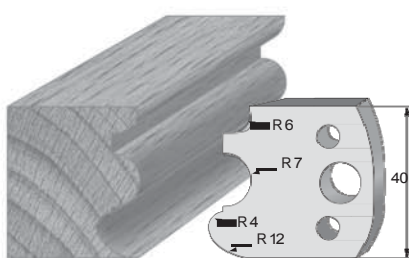

Profile number **88**

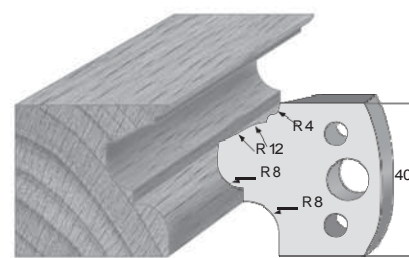

Profile number **89**



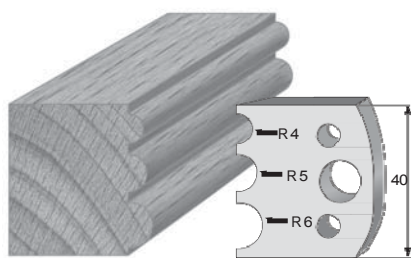

Profile number **90**

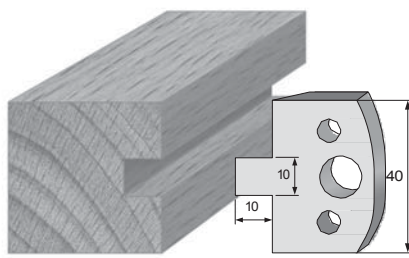

Profile number **91**

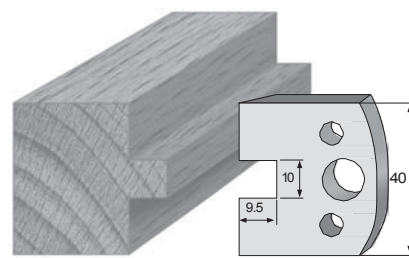

Profile number **92**

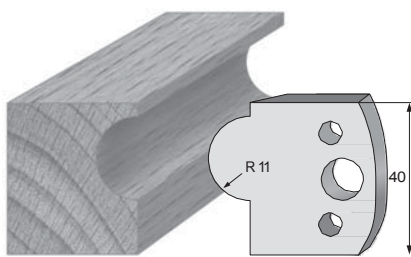

Profile number **93**

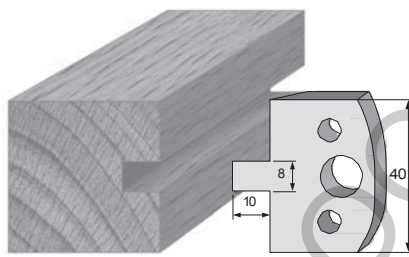

Profile number **94**

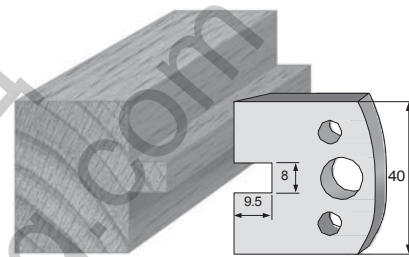

Profile number **95**

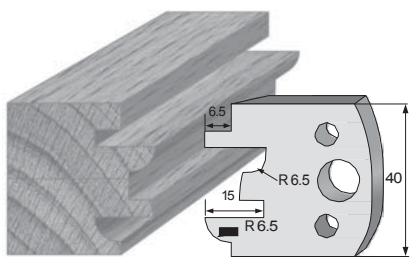

Profile number **96**

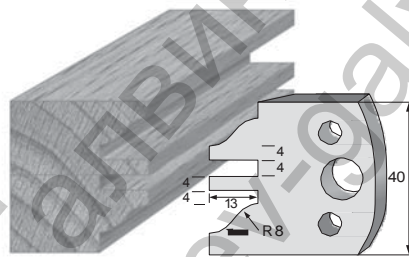

Profile number **97**

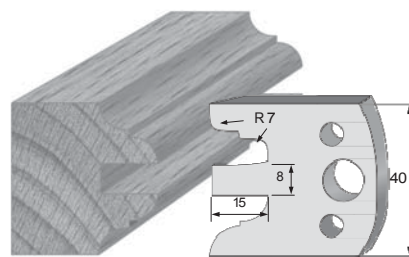

Profile number **98**

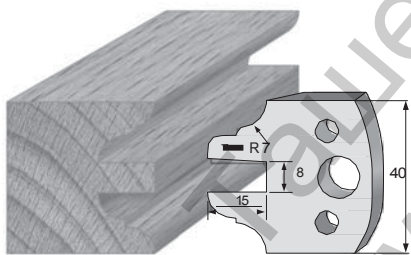

Profile number **99**

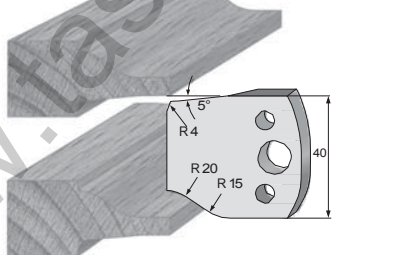

Profile number **100**